

**20.70.1800.00**

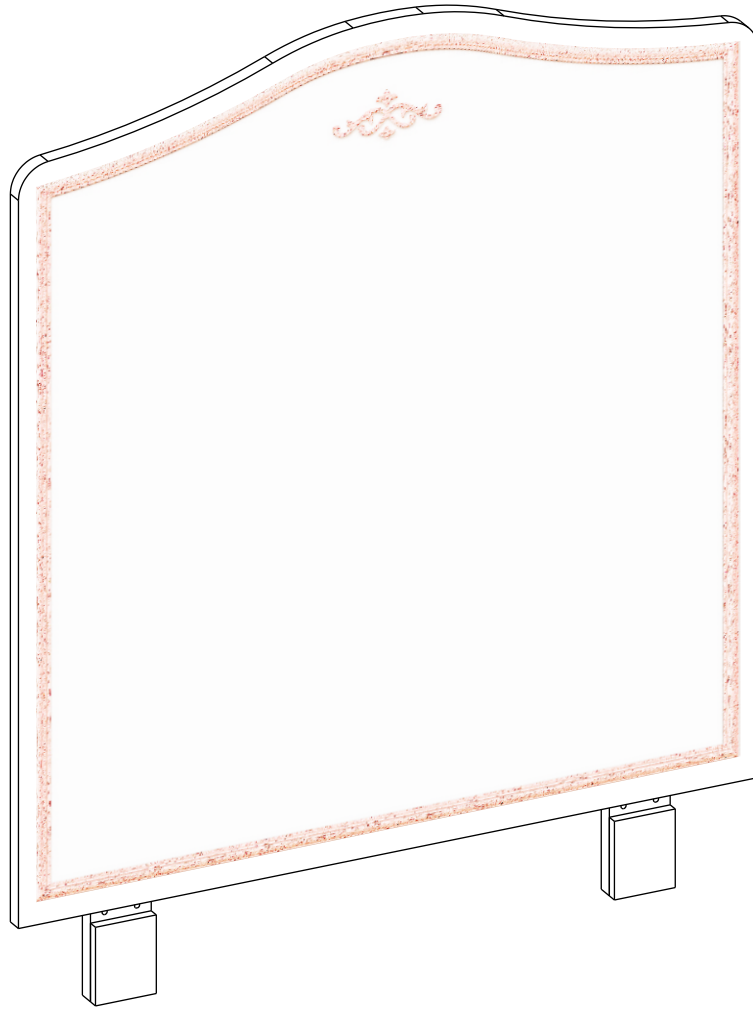

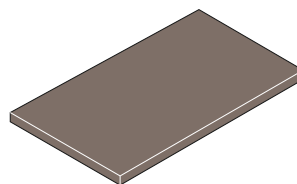



1 / 1

1 / 1

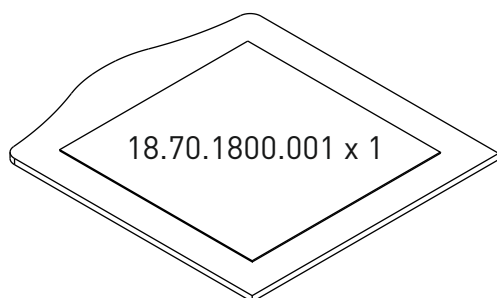

18.70.1800.001 x 1

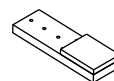

18.70.1800.002 x 2

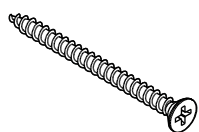

13.02.01.009 x 4  
4x40

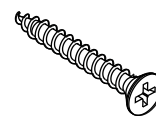

13.02.01.006 x 6  
4x25

1

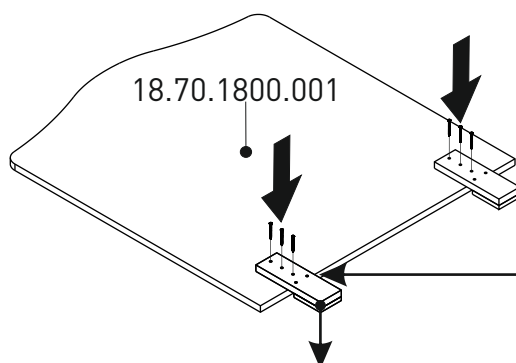

18.70.1800.002 x 2



13.02.01.006 x 6  
4x25

2

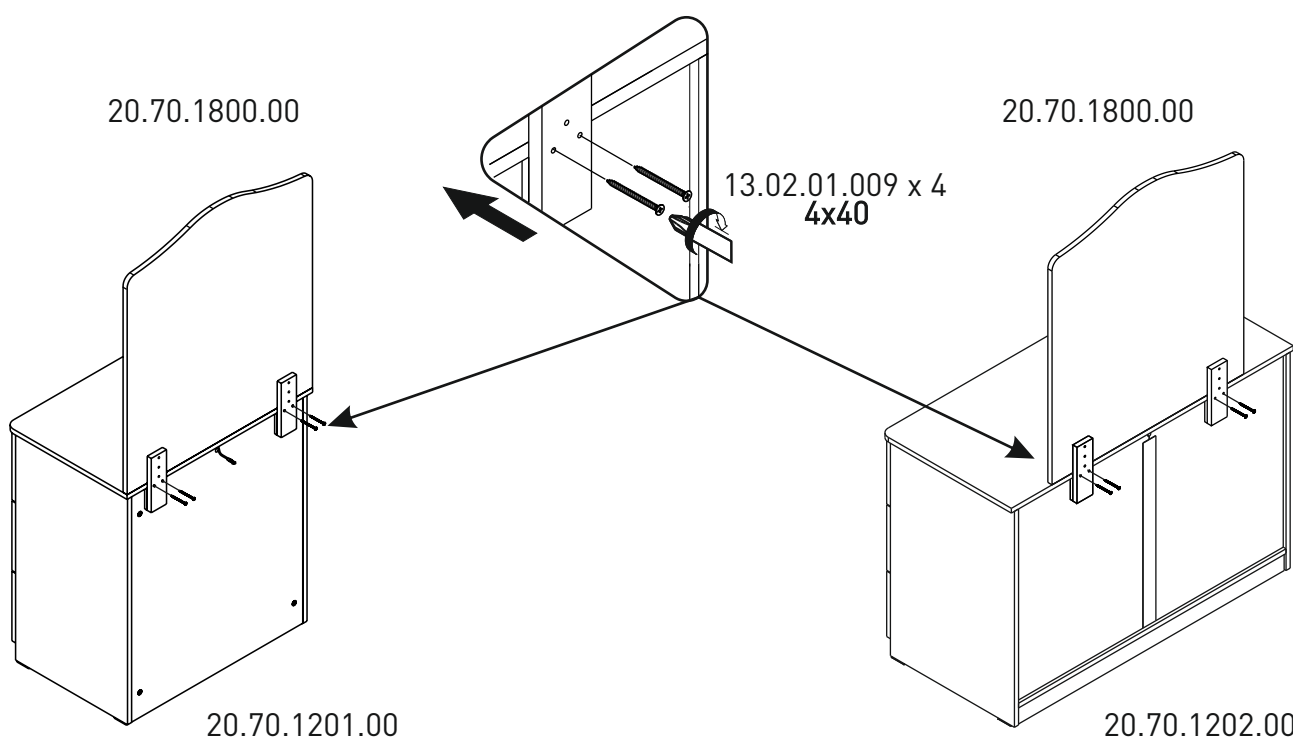

20.70.1201.00

20.70.1202.00