

20.75.1302.00

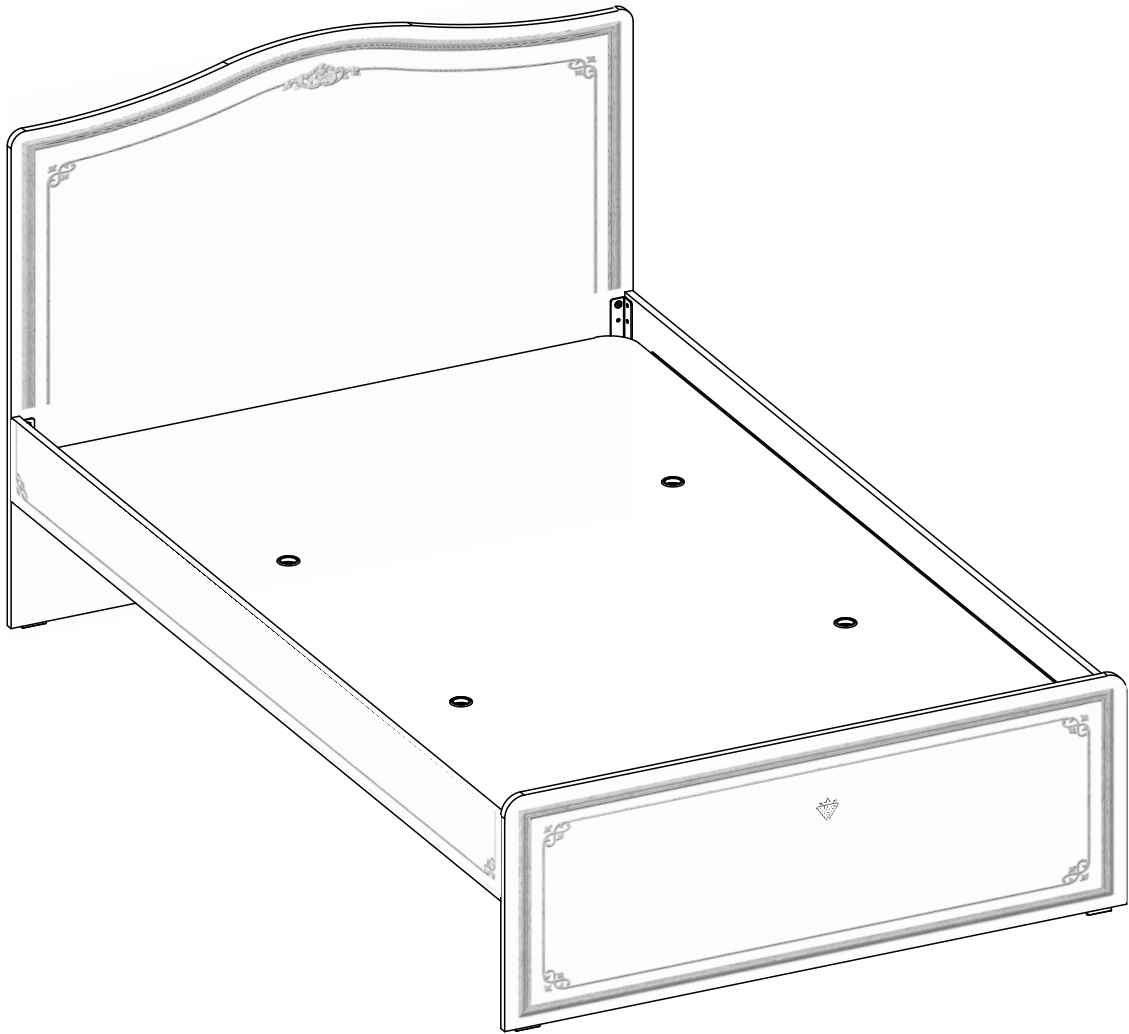

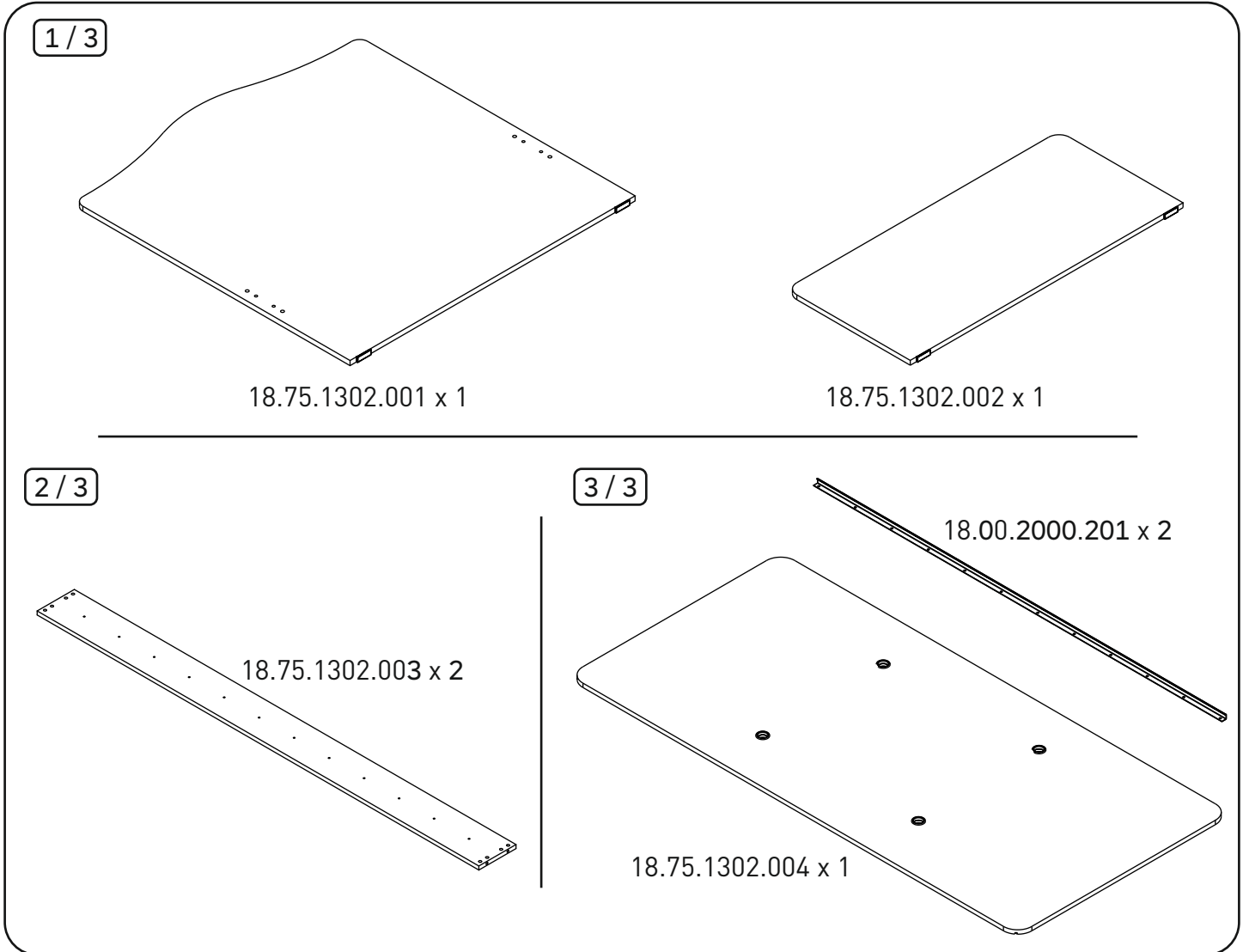

1

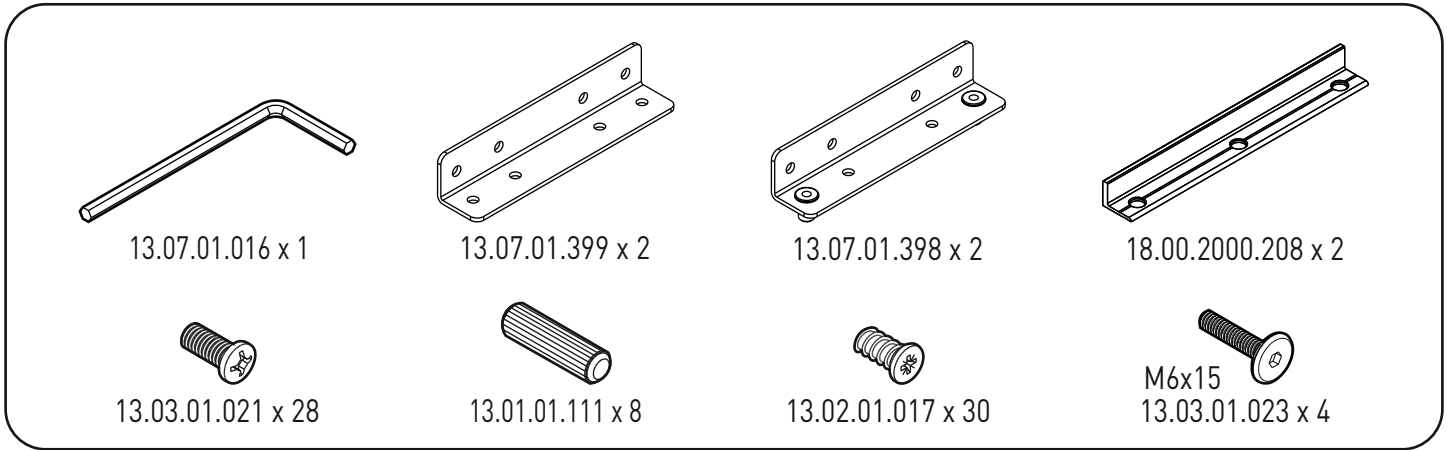
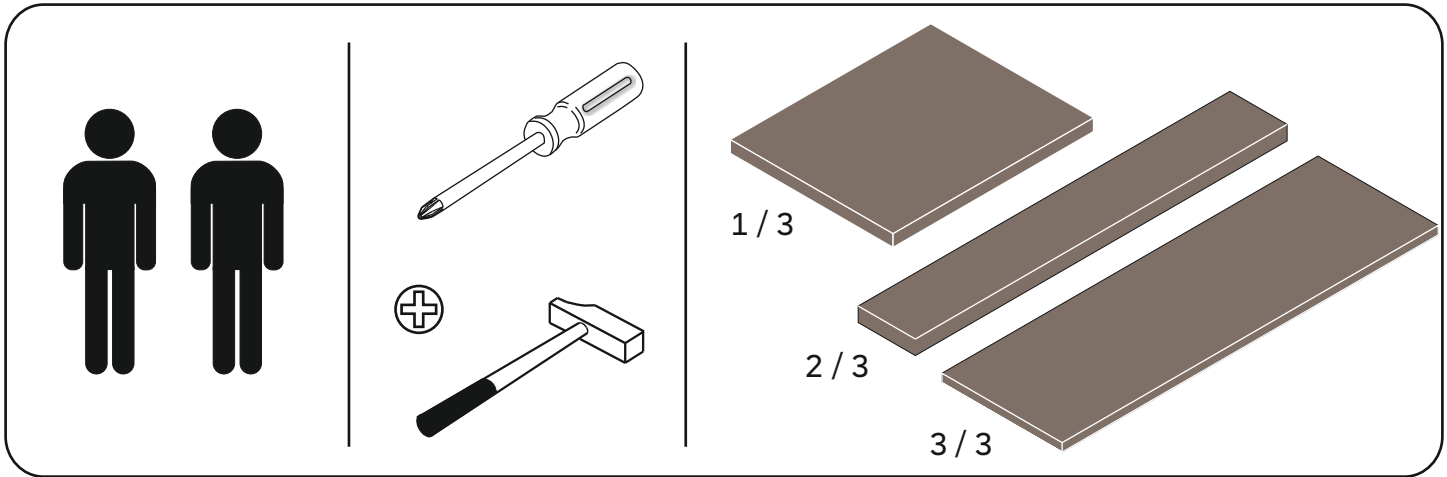
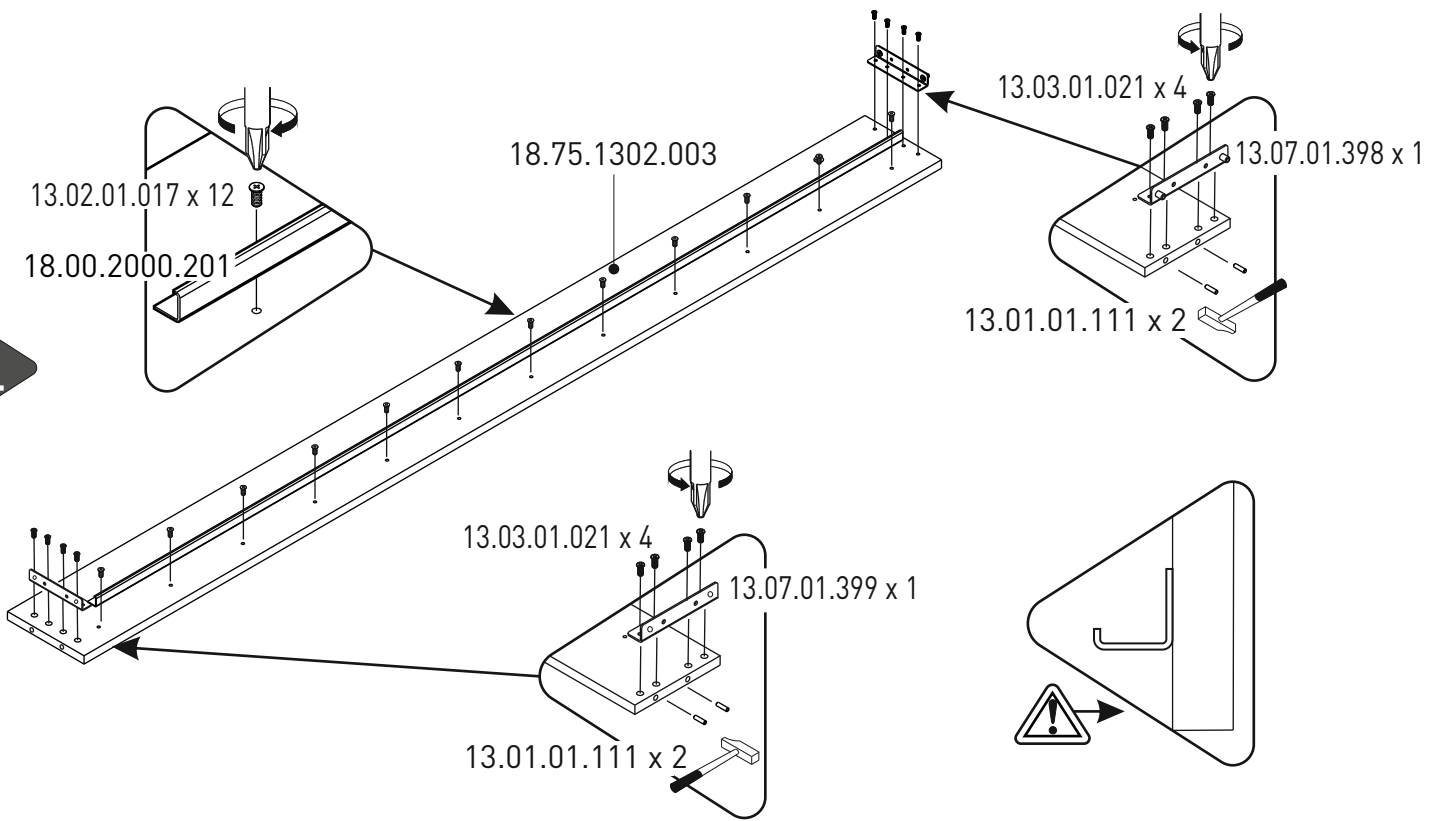

2

